

Silicon Triac

40529

2,5A Triac

200V / 2,5A

DATASHEET

OEM –RCA

Source: RCA Databook 1975

File No. 470

Thyristors

T2300 T2302 T2310 T2312 Series



2.5-Ampere Sensitive-Gate Silicon Triacs

For Low-Power Phase-Control and Load-Switching Applications

For Low-Voltage Operation — T2300A, T2302A, T2310A, T2312A (40525, 40528, 40531, 40534)*

For 120-V Line Operation — T2300B, T2302B, T2310B, T2312B (40526, 40529, 40532, 40535)*

For 240-V Line Operation — T2300D, T2302D, T2310D, T2312D (40527, 40530, 40533, 40536)*

*Numbers in parentheses (e.g. 40525) are former RCA type numbers.

Features:

- Very High Gate Sensitivity
3 mA max. for T2300 and T2310 series
10 mA max. for T2302 and T2312 series
- 3-Lead Package for Printed Circuit Board Applications
■ Shorted Emitter Design

RCA T2300-, T2302-, T2310-, and T2312-series triacs are gate-controlled full-wave ac silicon switches. They are designed to switch from a blocking state to a conducting state for either polarity of applied voltage with positive or negative gate triggering.

The T2302 series has higher dv/dt capability and higher gate trigger current requirements than the T2300 series. The gate sensitivity of these triacs permits the use of economical transistorized and IC control circuits and enhances their use in low-power phase control and load-switching applications.

The T2300 series has rms on-state current ratings of 2.5 amperes at a case temperature of +60°C while the T2302 series has the same ratings at a case temperature of +70°C.

The repetitive peak off-state voltage rating for T2300A and T2302A is 100 volts; for T2300B and T2302B, 200 volts; and for T2300D and T2302D, 400 volts.

The T2310 and T2312 series are the same as the T2300 and T2302 series, respectively, but have factory-attached heat-radiators and are intended for printed-circuit-board applications.

MAXIMUM RATINGS, Absolute-Maximum Values:

For Operation with 50/60-Hz, Sinusoidal Supply Voltage and Resistive or Inductive Load

REPETITIVE PEAK OFF-STATE VOLTAGE* (Gate Open):

$T_J = -40^\circ\text{C to } +90^\circ\text{C}$:	T2300A, T2310A	100	V
	T2300B, T2310B	200	V
	T2300D, T2310D	400	V
$T_J = -40^\circ\text{C to } +100^\circ\text{C}$:	T2302A, T2312A	100	V
	T2302B, T2312B	200	V
	T2302D, T2312D	400	V

V_{DROM}

RMS ON-STATE CURRENT (Conduction Angle = 360°):

$T_C = 60^\circ\text{C}$:	T2300 series	2.5	A
$T_C = 70^\circ\text{C}$:	T2302 series	2.5	A
$T_A = 25^\circ\text{C}$:	T2300 series	0.35	A
	T2302 series	0.40	A

I_T (RMS)

For other conditions See Figs. 2, 3, 4 & 5
For heat-radiator types See Figs. 6 & 7

PEAK SURGE (NON-REPETITIVE) ON-STATE CURRENT:

For one full cycle of applied principal voltage			
60 Hz sinusoidal	25	A	
50 Hz sinusoidal	21	A	
For more than one full cycle of applied voltage			See Fig. 8

I_{TSM}

PEAK GATE-TRIGGER CURRENT*:

For 1 μs max.	0.5	A
--------------------------	-----	---

I_{GTM}

T2300, T2302, T2310, and T2312 Series _____ File No. 470

MAXIMUM RATINGS (Cont'd)

GATE POWER DISSIPATION*:

Peak (For 1 μ s max.)	P_{GM}	10	W
Average: $T_C = 60^\circ\text{C}$	P_G (AV)	0.15	W
$T_A = 25^\circ\text{C}$		0.05	W

TEMPERATURE RANGE†:

Storage		-40 to +150	$^\circ\text{C}$
Operating (case): 40525, 40526, 40527		-40 to +90	$^\circ\text{C}$
40528, 40529, 40530		-40 to +100	$^\circ\text{C}$
Heat-radiator types (From -40°C) Upper limits.		See Figs. 6 & 7	

LEAD TEMPERATURE:

During soldering, terminal temperature at a distance $\geq 1/16$ in. (1.58 mm) from the case for 10 s		225	$^\circ\text{C}$
-------------------------------------------------------------------------------------------------------	--	-----	------------------

* For either polarity of main terminal 2 voltage (V_{MT2}) with reference to main terminal 1. † For either polarity of gate voltage (V_G) with reference to main terminal 1. ‡ For information on the reference point of temperature measurement see *Dimensional Outlines*.

ELECTRICAL CHARACTERISTICS

At Maximum Ratings and at Indicated Case Temperature (T_C) Unless Otherwise Specified

CHARACTERISTIC	SYMBOL	LIMITS						UNITS
		T2300 Series T2310 Series			T2302 Series T2312 Series			
		MIN.	TYP.	MAX.	MIN.	TYP.	MAX.	
Peak Off-State Current: \ddagger Gate Open and $V_{DROM} = \text{Max. rated value}$ At $T_j = +100^\circ\text{C}$ At $T_j = +90^\circ\text{C}$	I_{DROM}	-	-	-	-	0.2	0.75	mA
Maximum On-State Voltage: \ddagger For $i_T = 10\text{ A (peak)}$ and $T_C = 25^\circ\text{C}$	V_{TM}	-	1.7	2.2	-	1.7	2.2	V
DC Holding Current: \ddagger Gate Open, Initial principal current = 150 mA (DC), $V_D = 12$ At $T_C = 25^\circ\text{C}$ For other case temperatures	I_{HO}	-	2	5	-	6.5	15	mA
Critical Rate-of-Rise of Off-State Voltage: \ddagger For $V_D = V_{DROM}$, exponential voltage rise, and gate open At $T_C = +100^\circ\text{C}$ At $T_C = +90^\circ\text{C}$	dv/dt	-	-	-	-	10	-	V/ μ s
DC Gate-Trigger Current: \ddagger † For $V_D = 12\text{ V (DC)}$, $R_L = 30\ \Omega$, and $T_C = 25^\circ\text{C}$ For other case temperatures	I_{GT}	-	1	3	-	3.5	10	mA
DC Gate-Trigger Voltage: \ddagger † For $V_D = 12\text{ V (DC)}$ and $R_L = 30\ \Omega$ At $T_C = 25^\circ\text{C}$ For other case temperatures For $v_D = V_{DROM}$ and $R_L = 125\ \Omega$ At $T_C = 100^\circ\text{C}$ At $T_C = +90^\circ\text{C}$	V_{GT}	-	1	2.2	-	1	2.2	V
Thermal Resistance, Junction-to-Case: Steady-State	$R_{\theta JC}$	8.5 (max.) (T2300 series)			8.5 (max.) (T2302 series)			$^\circ\text{C/W}$

* For either polarity of main terminal 2 voltage (V_{MT2}) with reference to main terminal 1.

† For either polarity of gate voltage (V_G) with reference to main terminal 1.

File No. 470 _____ T2300, T2302, T2310, and T2312 Series

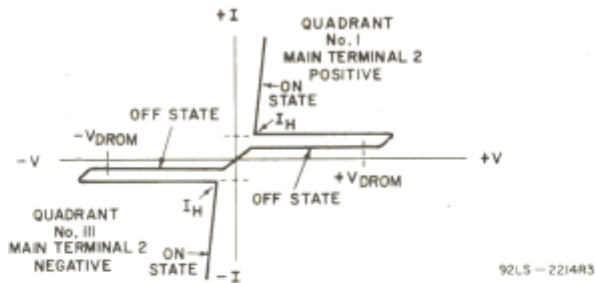

Fig. 1 - Principal voltage-current characteristics.

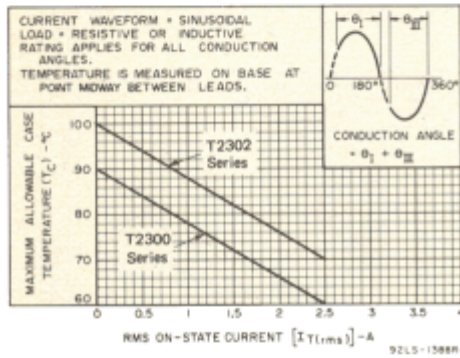

Fig. 2 - Conduction rating chart (case temperature) for T2300 and T2302 series.

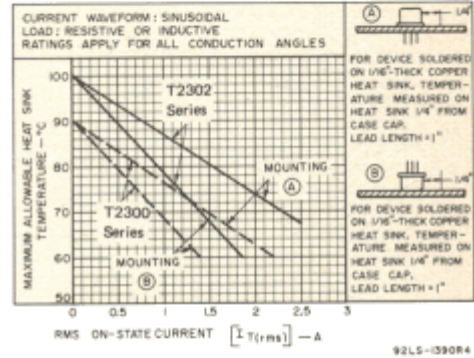

Fig. 3 - Conduction characteristics as a function of mounting method for T2300 and T2302 series.

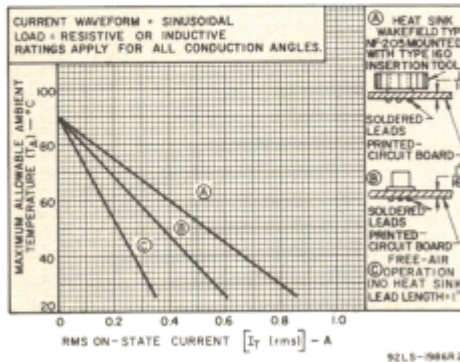

Fig. 4 - Conduction rating chart (ambient temperature) for T2300 series.

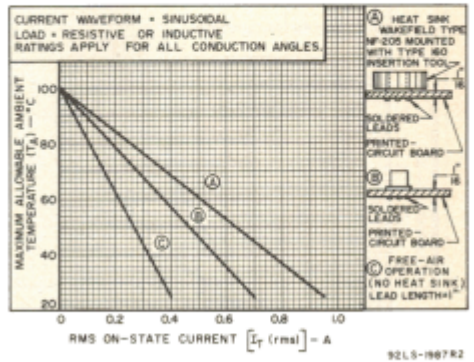

Fig. 5 - Conduction rating chart (ambient temperature) for T2302 series.

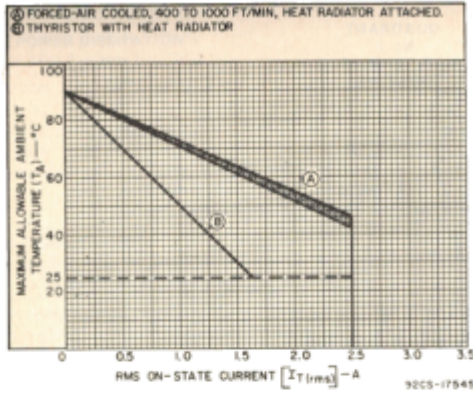

Fig. 6 - Conduction rating chart (ambient temperature) for T2310 series.

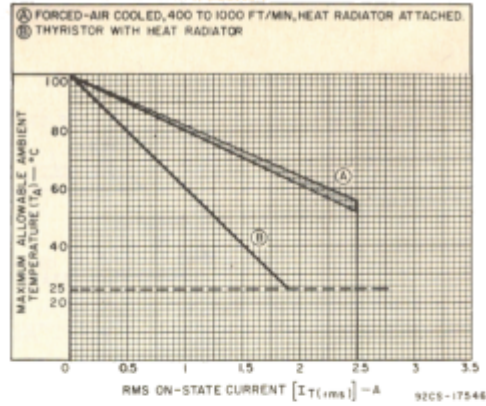

Fig. 7 - Conduction rating chart (ambient temperature) for T2312 series.

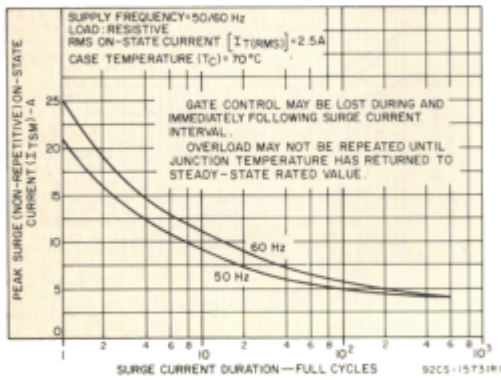

Fig. 8 - Peak surge on-state current vs. surge-current duration for all types.

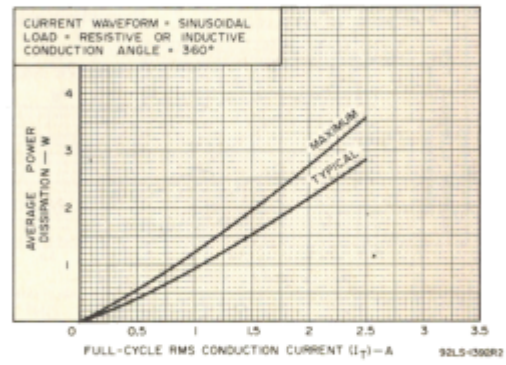

Fig. 9 - Power dissipation curves for all types.

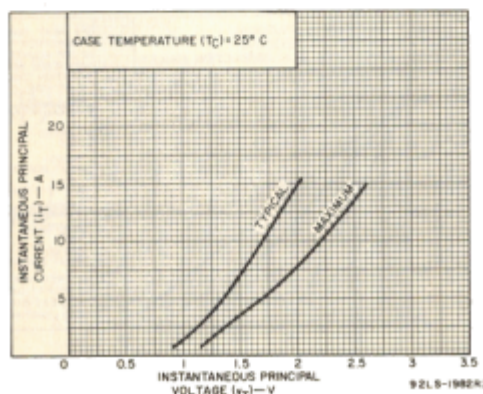

Fig. 10 - On-state characteristics for either direction of principal current for all types.

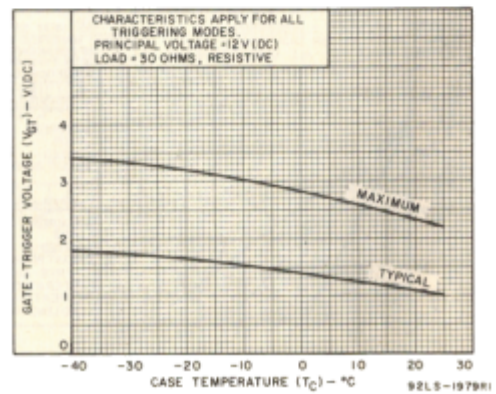

Fig. 11 - DC Gate-trigger voltage characteristics for all types.

File No. 470

T2300, T2302, T2310, and T2312 Series

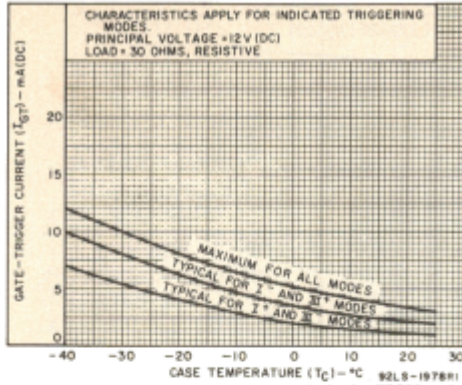

Fig. 12 - DC gate-trigger current characteristics for T2300 and T2310 series.

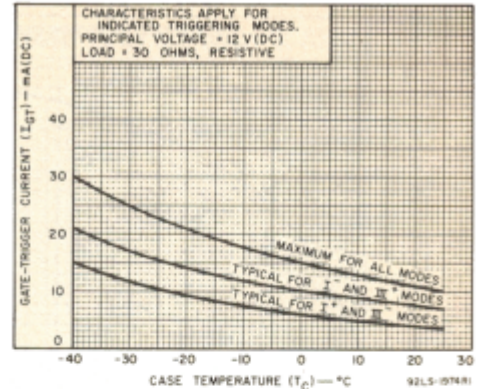

Fig. 13 - DC gate-trigger current characteristics for T2302 and T2312 series.

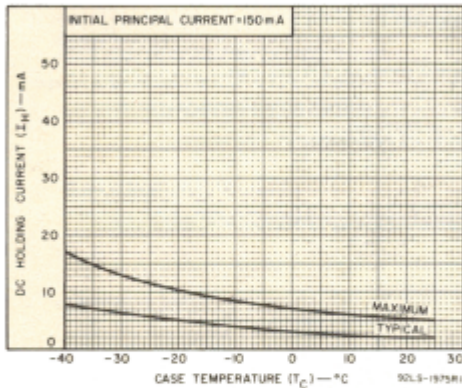

Fig. 14 - DC holding current characteristics for either direction of principal current for T2300 and T2310 series.

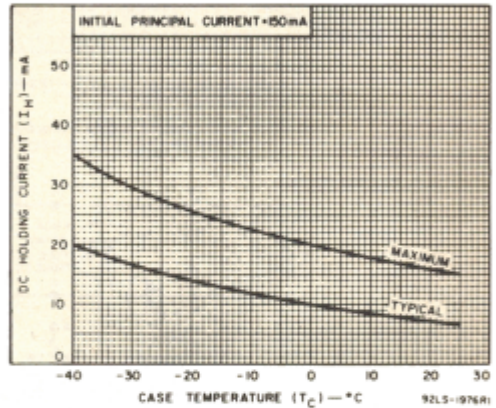

Fig. 15 - DC holding current characteristics for either direction of principal current for T2302 and T2312 series.

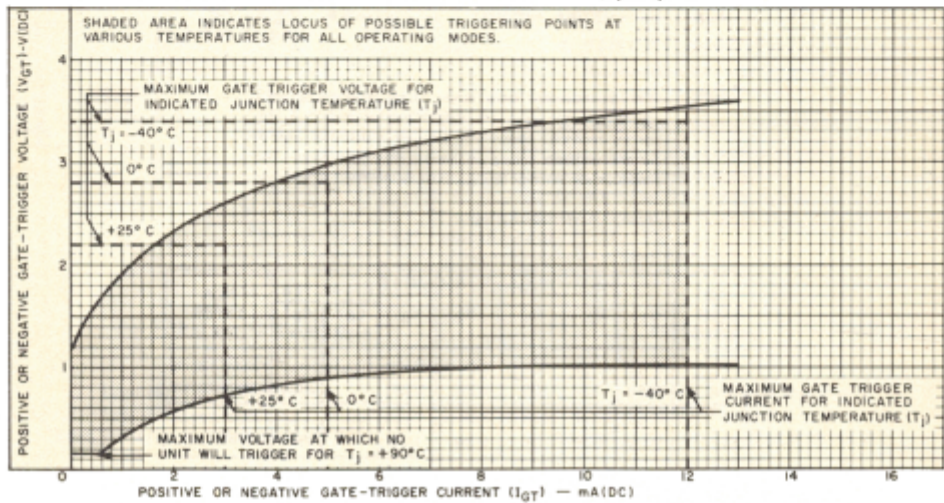

Fig. 16 - Gate characteristics for T2300 and T2310 series.

92LM-1983R1

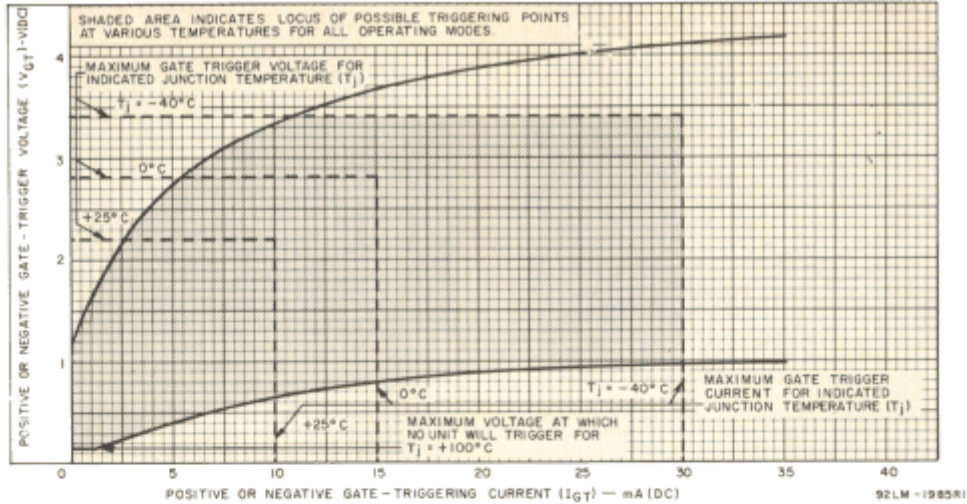
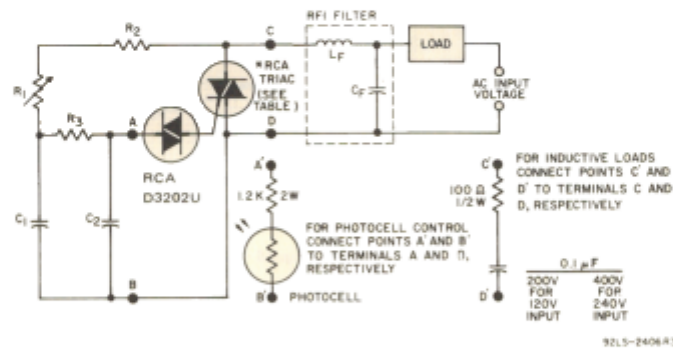

Fig. 17 - Gate characteristics for T2302 and T2312 series.



NOTE: For incandescent lamp loads which produce burnout current surges with I^2t values greater than 2.5 ampere² seconds, connect a 10-ohm resistor of appropriate wattage rating in series with the load. The appropriate wattage rating can be determined as follows:

$$\text{Wattage Rating of 10-ohm Resistor} = 10 \times (\text{rms load current})^2$$

AC INPUT VOLTAGE	C ₁	C ₂	R ₁	R ₂	R ₃	RFI FILTER		RCA TYPES
						L _F * (typ.)	C _F * (typ.)	
120V 60Hz	0.1μF	0.1μF	100KΩ	2.2KΩ	15KΩ	100μH	0.1μF	T2300B, T2310B
	200V	100V	1/2W	1/2W	1/2W		200V	T2302B, T2312B
240V 50Hz	0.1μF	0.1μF	250KΩ	3.5KΩ	15KΩ	200μH	0.1μF	T2300D, T2302D
	400V	100V	1W	1/2W	1/2W		400V	T2310D, T2312D

*Typical values for lamp dimming circuits.

Fig. 18 - Typical phase-control circuit for lamp dimming, heat controls, and universal motor speed controls.

File No. 470 _____ T2300, T2302, T2310, and T2312 Series

DIMENSIONAL OUTLINE FOR T2300 AND T2302 SERIES

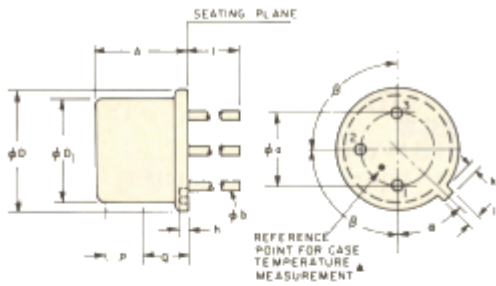

SYMBOL	INCHES		MILLIMETERS		NOTES
	MIN.	MAX.	MIN.	MAX.	
phi D	0.190	0.210	4.83	5.33	
A	0.240	0.260	6.10	6.60	
phi b	0.017	0.021	0.44	0.53	
phi D	0.335	0.366	8.51	9.30	
phi D1	-	0.330	8.13	8.38	
h	0.015	0.035	0.38	0.89	
I	0.028	0.035	0.71	0.89	
k	0.029	0.045	0.74	1.14	
l	0.975	1.025	24.76	26.03	
P	0.100	-	2.54	-	
Q	-	-	-	-	1
alpha	45° NOMINAL		-	-	
beta	50° NOMINAL		-	-	

Note 1 Details of outline in this zone optional. 92LM 2048R2

*The temperature reference point specified should be used when making temperature measurements. A low-mass temperature probe or thermocouple having wire no larger than AWG No. 16 should be attached at the temperature reference point.

DIMENSIONAL OUTLINE FOR T2310 AND T2312 SERIES

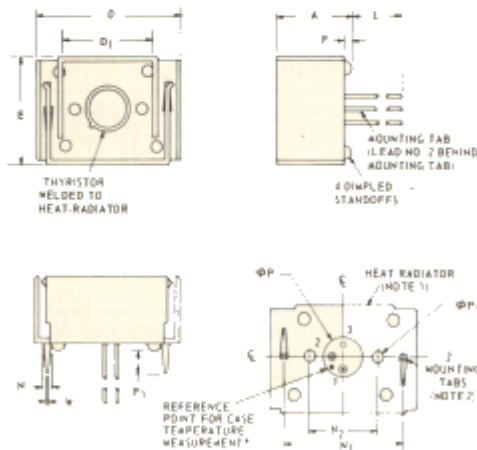

SYMBOL	INCHES		MILLIMETERS		NOTES
	MIN.	MAX.	MIN.	MAX.	
A	-	0.630	-	16.00	
D	1.205	1.235	30.61	31.37	
D1	0.775	0.785	19.69	19.93	
E	0.875	0.905	22.22	22.99	
F	0.040	0.055	1.02	1.40	
F1	0.160	0.195	4.06	4.94	
L	0.920	-	23.37	-	
phi P	0.295	0.305	7.493	7.747	
phi P1	0.093	0.095	2.362	2.413	
N	0.048	0.062	1.21	1.57	
N1	0.996	1.002	25.349	25.490	3
N2	0.687	0.689	17.45	17.50	3
W	0.046	0.052	1.219	1.320	

NOTES:

- 0.035 C.R.S., finish: electroless nickel plate
- Recommended hole size for printed-circuit board is 0.070 in. (1.78 mm) dia.
- Measured at bottom of heat-radiator

*The specified temperature-reference point should be used when making temperature measurements. A low-mass temperature probe or thermocouple having wire no larger than AWG No. 26 should be attached at the temperature reference point.

TERMINAL CONNECTIONS

For T2300 and T2302 series

- Lead No. 1 – Main terminal 1
- Lead No. 2 – Gate
- Case, Lead No. 3 – Main terminal 2

For T2310 and T2312 series

- Lead No. 1 – Main terminal 1
- Lead No. 2 – Gate
- Heat Rad., Lead No. 3 – Main terminal 2