

Bridge Rectifier

GBPC12005W

50V / 12A

DATASHEET

from

www.web-bcs.com

OEM – General Semiconductor

Source: General Semiconductor Databook 1998

GBPC12, 15, 25 AND 35 SERIES

GLASS PASSIVATED SINGLE-PHASE BRIDGE RECTIFIER

Reverse Voltage - 50 to 1000 Volts Current Voltage - 12.0 to 35.0 Amperes

GBPC - W Wire leads



GBPC - Standard



FEATURES

- ◆ The plastic package has Underwriters Laboratory Flammability Classification 94V-0
- ◆ This series is UL recognized under component index, file number E54214
- ◆ Integrally molded heatsink provides very low thermal resistance for maximum heat dissipation
- ◆ Universal 3-way terminals; snap-on, wire wrap-around, or P.C.B. mounting
- ◆ High forward surge current capabilities
- ◆ Glass passivated chip junctions
- ◆ Typical I_R less than 0.3μA
- ◆ High temperature soldering guaranteed:
260°C/10 seconds at 5lbs. (2.3 kg) tension

MECHANICAL DATA

Case: Molded plastic with heatsink integrally mounted in the bridge encapsulation
Terminals: Either plated 0.25" (6.35mm). Faston lugs or plated copper leads 0.040" (1.02mm) diameter. Suffix letter "W" added to indicate leads (e.g. GBPC12005W).
Mounting Position: See NOTE 3
Polarity: Polarity symbols molded on body
Mounting Torque: 20 in. - lb. max. **Weight:** 0.53 ounce, 15 grams

MAXIMUM RATINGS AND ELECTRICAL CHARACTERISTICS

Ratings at 25°C ambient temperature unless otherwise specified.

		GBPC12, 15, 25, 35								
		SYMBOLS	005	01	02	04	06	08	10	UNITS
Maximum repetitive peak reverse voltage		V _{RRM}	50	100	200	400	600	800	1000	Volts
Maximum RMS voltage		V _{RMS}	35	70	140	280	420	560	700	Volts
Maximum DC blocking voltage		V _{DC}	50	100	200	400	600	800	1000	Volts
Maximum average forward rectified output current (SEE FIG. 1)	GBPC12 GBPC15 GBPC25 GBPC35	I _(AV)				12.0 15.0 25.0 35.0				Amps
Peak forward surge current single sine-wave superimposed on rated load (JEDEC Method)	GBPC12 GBPC15 GBPC25 GBPC35	I _{FSM}				200.0 300.0 300.0 400.0				Amps
Rating (non-repetitive, for t greater than 1ms and less than 8.3ms) for fusing	GBPC12 GBPC15 GBPC25 GBPC35	I _t				160.0 375.0 375.0 660.0				A ² sec
Maximum instantaneous forward voltage drop per leg at	GBPC12 I _F =6.0A GBPC15 I _F =7.5A GBPC25 I _F =12.5A GBPC35 I _F =17.5A	V _F				1.1				Volts
Maximum reverse DC current at rated DC blocking voltage per leg	T _A =25°C T _A =125°C	I _R				5.0 500.0				μA
RMS isolation voltage from case to leads		V _{ISO}				2500.0				Volts
Typical junction capacitance per leg (NOTE 1)		C _J				300.0				pF
Typical thermal resistance per leg (NOTE 2)	GBPC12-25 GBPC35	R _{θJC}				1.9 1.4				°C/W
Operating junction storage temperature range		T _J , T _{STG}				-55 to +150				°C

NOTES:

- (1) Measured at 1.0 MHz and applied reverse voltage of 4.0 Volts
- (2) Thermal resistance from junction to case per leg
- (3) Bolt down on heat-sink with silicone thermal compound between bridge and mounting surface for maximum heat transfer efficiency with #10 screw

RATINGS AND CHARACTERISTICS CURVES GBPC12, 15, 25 AND 35 SERIES

FIG. 1 - MAXIMUM OUTPUT RECTIFIED CURRENT

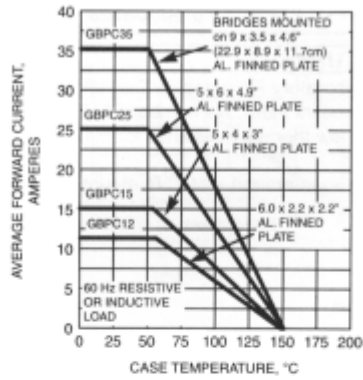

FIG. 2 - MAXIMUM OUTPUT RECTIFIED CURRENT

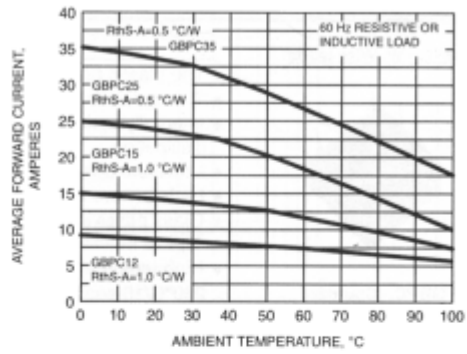

FIG. 3 - MAXIMUM POWER DISSIPATION

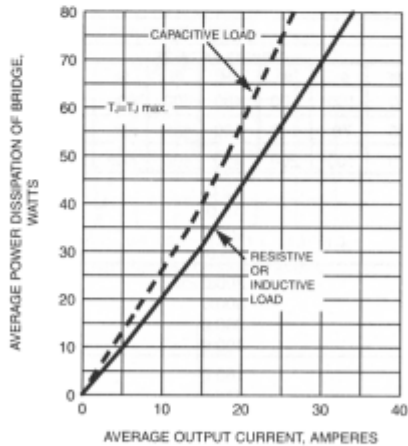
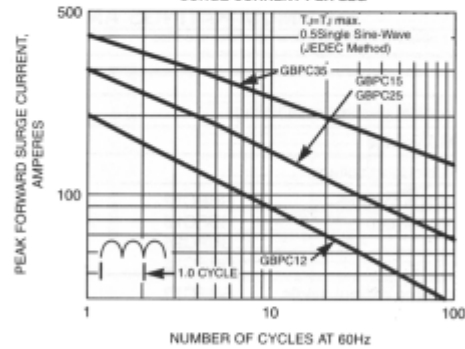

FIG. 4 - MAXIMUM NON-REPETITIVE PEAK FORWARD SURGE CURRENT PER LEG



RATINGS AND CHARACTERISTICS CURVES GBPC12, 15, 25 AND 35 SERIES

FIG. 5 - TYPICAL INSTANTANEOUS FORWARD CHARACTERISTICS PER LEG

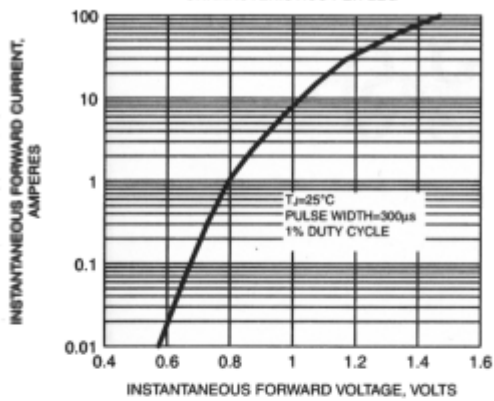

FIG. 6 - TYPICAL REVERSE LEAKAGE CHARACTERISTICS PER LEG

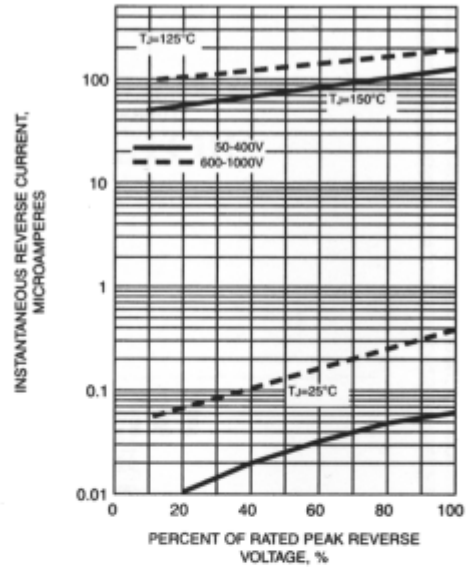

FIG. 7 - TYPICAL JUNCTION CAPACITANCE PER LEG

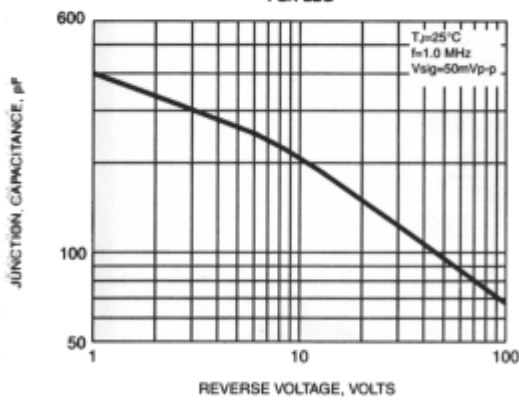

FIG. 8 - TYPICAL TRANSIENT THERMAL IMPEDANCE PER LEG

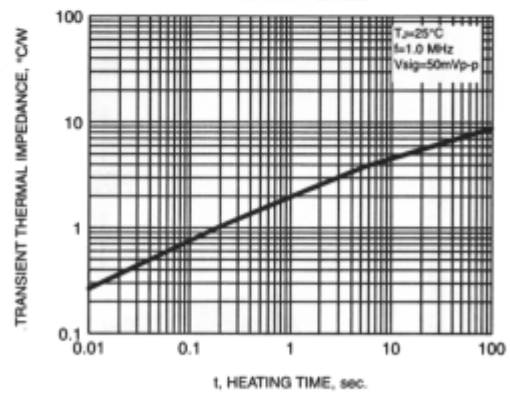

FIG. 9

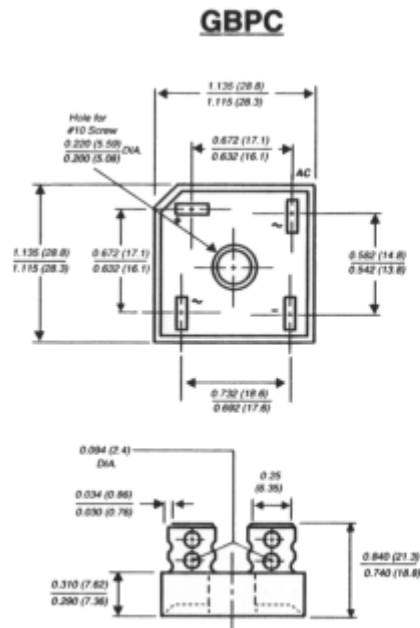
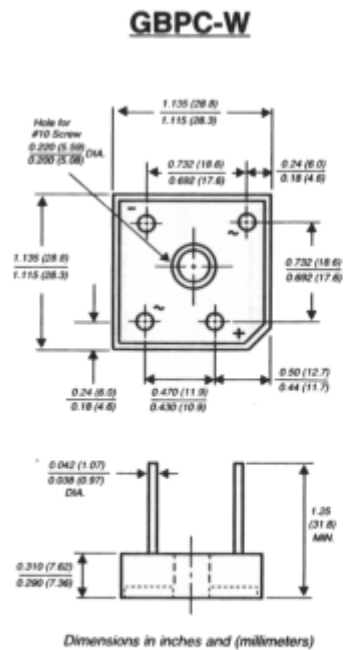

FIG. 10



NOTES:

- (1) Corrosion resistant terminals designed with 0.25" female quick connectors for wrap or snap-on
- (2) A thin film of silicone thermal compound is recommended between the bridge case and mounting surface for improved thermal conduction