

Silicon – Diode Array

FSA2719P

8 Diode Array

75V/350mA

DATASHEET

OEM – Fairchild

Source: Fairchild Databook 1978

**FSA2619M•FSA2619P•FSA2620M•FSA2620P
FSA2621M•FSA2719M•FSA2719P•FSA2720M
FSA2720P•FSA2721M**

PLANAR AIR-ISOLATED MONOLITHIC DIODE ARRAYS

- C... 2.0 pF (MAX) FSA2719 Series
- ΔV_F ... 15 mV (MAX) @ 10 mA

ABSOLUTE MAXIMUM RATINGS (Notes 1 and 5)

Temperatures

Storage Temperature Range (M Suffix) (P Suffix)	-55° C to +200° C
Maximum Junction Operating Temperature	-55° C to +150° C
Lead Temperature	+150° C +260° C

Power Dissipation (Note 2)

Maximum Dissipation per Junction at 25° C Ambient	400 mW
Maximum Dissipation per Package at 25° C Ambient	650 mW
Linear Derating factor (from 25° C) Junction	3.2 mW / °C
Package	5.2 mW / °C

Maximum Voltage and Currents

WIV	Working Inverse Voltage FSA2619 (Note 5) FSA2719	75 V 50 V
I_F	Continuous Forward Current	350 mA
I_F (surge)	Peak Forward Surge Current	
	Pulse Width = 1.0 s	1.0 A
	Pulse Width = 1.0 μ s	2.0 A

CONNECTION DIAGRAMS

FSA2619 • FSA2719

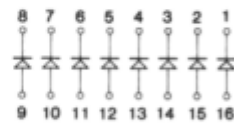

See Package Outlines

6B (Ceramic DIP)	FSA2619M FSA2719M
9B (Plastic DIP)	FSA2619P FSA2719P

ELECTRICAL CHARACTERISTICS (25° C Ambient Temperature unless otherwise noted)

SYMBOL	CHARACTERISTIC	MIN	MAX	UNITS	TEST CONDITIONS
BV	Breakdown Voltage (Note 5)	FSA2719 75		V	$I_R = 5.0 \mu A$
		FSA2619 100		V	$I_R = 100 \mu A$
I_R	Reverse Current		5.0 25 50 100 100	μA nA μA nA μA	$V_R = 75 V$ $V_R = 20 V$ $V_R = 20 V, T_A = 150^\circ C$ $V_R = 50 V$ $V_R = 50 V, T_A = 150^\circ C$
V_F	Forward Voltage (Note 3)		1.0	V	$I_F = 10 mA$
t_{rr}	Reverse Recovery Time (Note 6)	FSA2619 FSA2719	5.0 6.0	ns	$I_F = I_r = 10 mA, I_{rr} = 1.0 mA$ $I_F = I_r = 10 mA, I_{rr} = 1.0 mA$
C	Capacitance (Note 6)	FSA2619 FSA2719	4.0 2.0	pF pF	$V_R = 0$ $V_R = 0$
ΔV_F	Forward Voltage Match (Note 6)		15	mV	$I_F = 10 mA$
t_{fr}	Forward Recovery Time (Note 6)	FSA2619	20	ns	50 mA Peak square wave, 0.1 μs Pulse Width, 5.0 kHz - 100 kHz
V_{FM}	Peak Forward Voltage (Note 6)	FSA2719	3.0	V	$I_F = 100 mA, t_r \leq 10 ns$
RE	Rectification Efficiency	45		%	$V_I = 2 V rms, f = 100 MHz$

NOTES:

- These ratings are limiting values above which life or satisfactory performance may be impaired.
- These are steady state limits. The factory should be consulted or applications involving pulsed or low duty-cycle operation.
- V_F is measured using an 8 ns pulse.
- See test circuits (Note 6) for measurement of reverse current of an individual diode.
- FSA2619 denotes series FSA2619M/P, FSA2620M/P and FSA2621M.
FSA2719 denotes series FSA2719M/P, FSA2720M/P and FSA2721M.
- For product family characteristics curves and test circuits, refer to Chapter 4, D15.

*UNCONNECTED

FAIRCHILD • ZENER DIODES

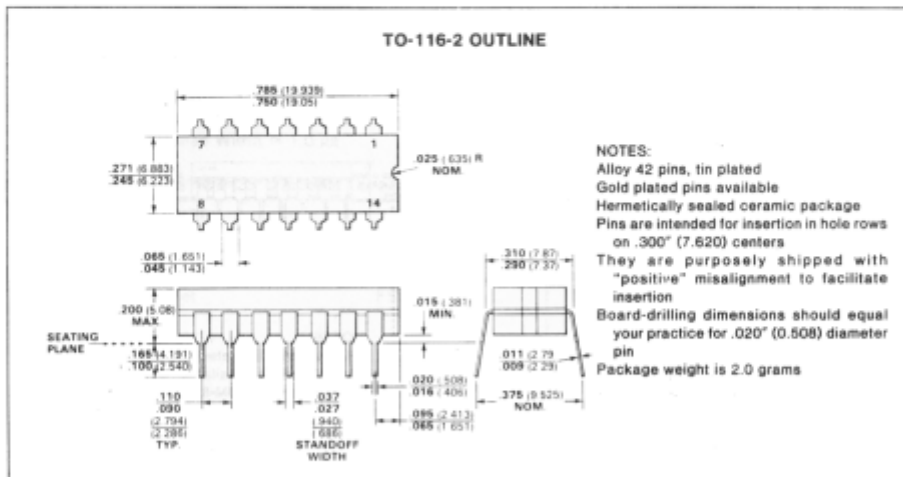
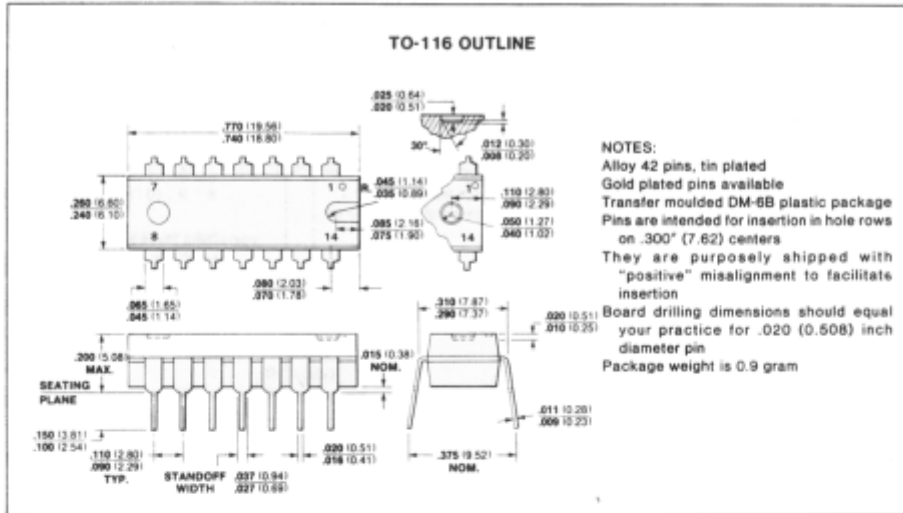

CURVE SET NUMBER D15
AIR-ISOLATED MONOLITHIC DIODE ARRAY

TYPICAL ELECTRICAL CHARACTERISTIC CURVES
 AT 25°C AMBIENT TEMPERATURE UNLESS OTHERWISE NOTED

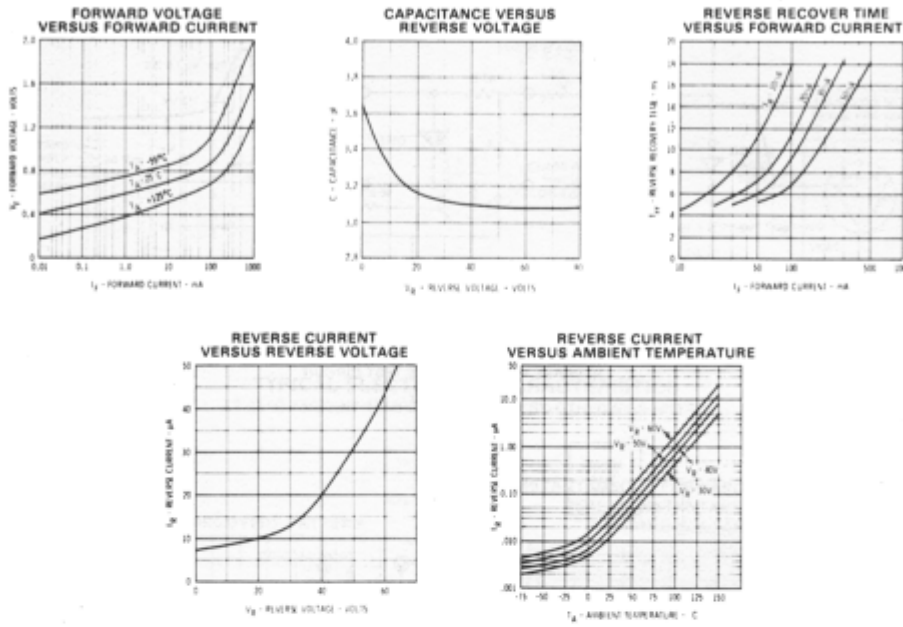

TEST CIRCUITS

To measure reverse current of an individual diode, the following test circuits are used:

COMMON CATHODE DIODES

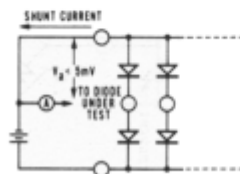

COMMON ANODE DIODES

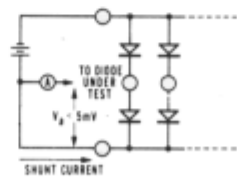

CURVE SET NUMBER D15
AIR-ISOLATED MONOLITHIC DIODE ARRAY

TEST CIRCUITS

Test requirement for V_{FM} and t_{rr} is as shown below; all leads should be as short as possible.

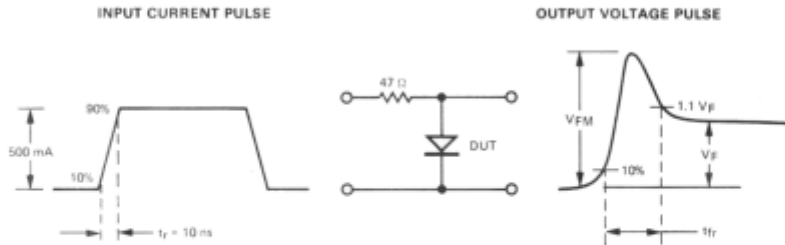

t_{rr} - REVERSE RECOVERY TIME TEST CIRCUIT
 $I_F = I_R = I_{rr} = 0.1 I_F$

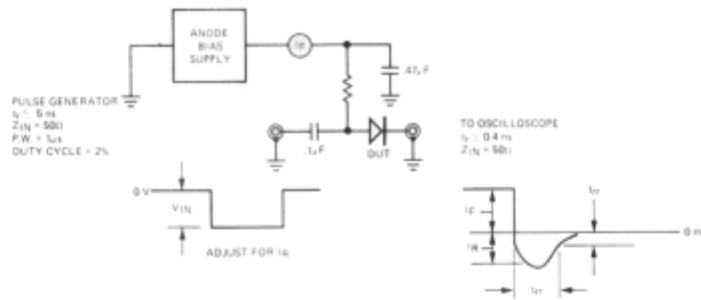

ΔV_F BRIDGE MATCHING CIRCUIT

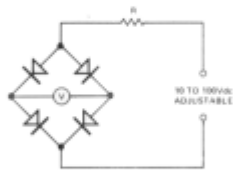

ΔI_R BRIDGE MATCHING CIRCUIT

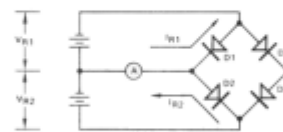

NOTES:

1. R Varies depending on the current range. For the most often used current ranges, R is as follows:

Current Range (amperes)	R (ohms)
10^{-5} to 10^{-4}	10^6
10^{-4} to 10^{-3}	10^5
10^{-3} to 10^{-2}	10^4
or 10^{-n} to 10^{-n+1}	10^{n+1}

2. V indicates mismatch of assembly.

NOTES:

- $V_{R2} = V_{R1} \pm 1\%$.
- $I_{R2} - I_{R1} = \Delta I_R$ (difference in I_R between diodes D1 & D2). To measure diodes D3 & D4, reverse cathode-anode terminal connections.
- A is a center reading picoammeter. ΔI_R indicated directly on A.