

Silicon Bridge - Diode

FSA2703M

60V/350mA

DATASHEET

OEM – Fairchild

Source: Fairchild Databook 1978

FSA2702M • FSA2703M • FSA2704M • FSA2705M

PLANAR AIR-ISOLATED MONOLITHIC DIODE BRIDGE ARRAYS

- ΔV_F ... 3 mV (MAX) FSA2702M, FSA2703M
- ΔI_R ... 1 μ A (MAX) FSA2702M, FSA2703M

ABSOLUTE MAXIMUM RATINGS (Note 1)

Temperatures

Storage Temperature Range	-55°C to +200°C
Maximum Junction Operating Temperature	175°C
Lead Temperature	+260°C

Power Dissipation (Note 2)

Maximum Dissipation	500 mW
Linear Derating Factor (from 25°C)	3.33 mW/°C

Maximum Voltage and Currents

WIV	Working Inverse Voltage	40 V
I_F	Continuous Forward Current	300 mA
i_F	Recurrent Peak Forward Current	600 mA
I_F (surge)	Peak Forward Surge Current	
	Pulse Width = 1.0 s	1.0 A
	Pulse Width = 1.0 μ s	4.0 A

CONNECTION DIAGRAM

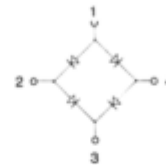

See Package Outlines

TO-33	FSA2702M, FSA2704M
TO-72	FSA2703M, FSA2705M

ELECTRICAL CHARACTERISTICS (25°C Ambient Temperature unless otherwise noted)

SYMBOL	CHARACTERISTIC	MIN	MAX	UNITS	TEST CONDITIONS
BV	Breakdown Voltage	60		V	$I_R = 100 \mu$ A
I_R	Reverse Current (Note 4)		100	nA μ A	$V_R = 40$ V $V_R = 40$ V, $T_A = 150^\circ$ C
C	Capacitance (Note 5)		4.0	pF	$V_R = 0$
V_F	Forward Voltage (Note 3)		1.000 .920 .850 .780 .740 .700 .650 .620	V	$I_F = 200$ mA $I_F = 100$ mA $I_F = 50$ mA $I_F = 20$ mA $I_F = 10$ mA $I_F = 5.0$ mA $I_F = 2.0$ mA $I_F = 1.0$ mA
t_{rr}	Reverse Recovery Time (Note 6)		6.0 8.0	ns	$I_F = I_R = 10$ mA, $t_{rr} = 1.0$ mA $I_F = I_R = 200$ mA, $t_{rr} = 20$ mA
ΔV_F	Forward Voltage Match (Note 6) FSA2702, FSA2703		3.0	mV	$I_F = 10 \mu$ A to 10 mA $T_A = -55^\circ$ C to $+100^\circ$ C
ΔI_R	Reverse Current Match (Note 6) FSA2702, FSA2703		1.0	μ A	$V_R = 10$ V, $T_A = -55^\circ$ C to $+100^\circ$ C

NOTES:

1. These ratings are limiting values above which life or satisfactory performance may be impaired.
2. These are steady state limits. The factory should be consulted on applications involving pulsed or low duty cycle operation.
3. V_C is measured using an 8 ns pulse.
4. See test circuits (Note 6) for measurement of reverse current of an individual diode.
5. The capacitance is measured from pin-to-pin across any one of the diodes. The interaction of other diodes is therefore included in the measured value.
6. For product family characteristic curves and test circuits, refer to Chapter 4, D15.

FAIRCHILD • DIODE ARRAYS

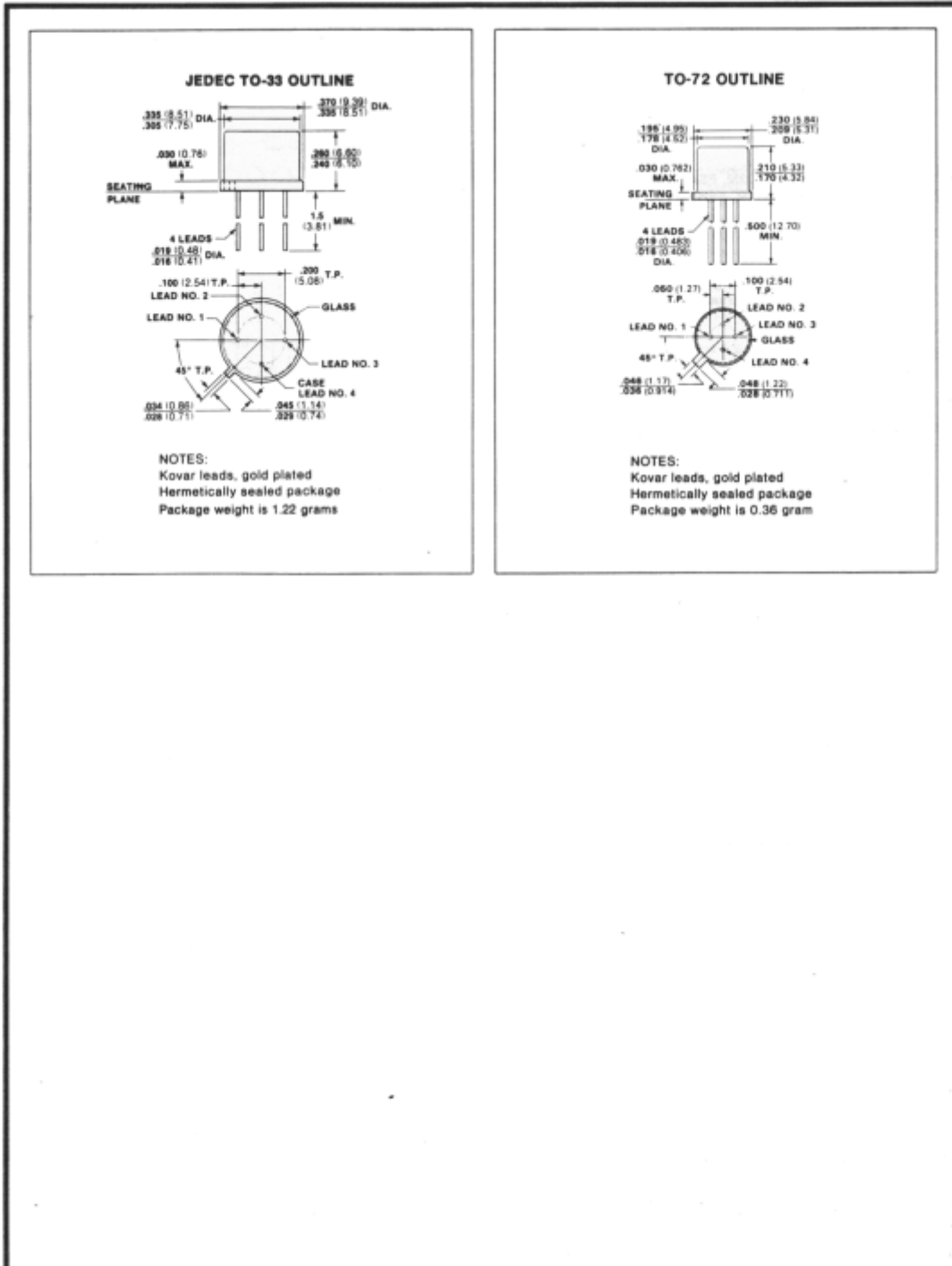

CURVE SET NUMBER D15
AIR-ISOLATED MONOLITHIC DIODE ARRAY

TYPICAL ELECTRICAL CHARACTERISTIC CURVES
 AT 25°C AMBIENT TEMPERATURE UNLESS OTHERWISE NOTED

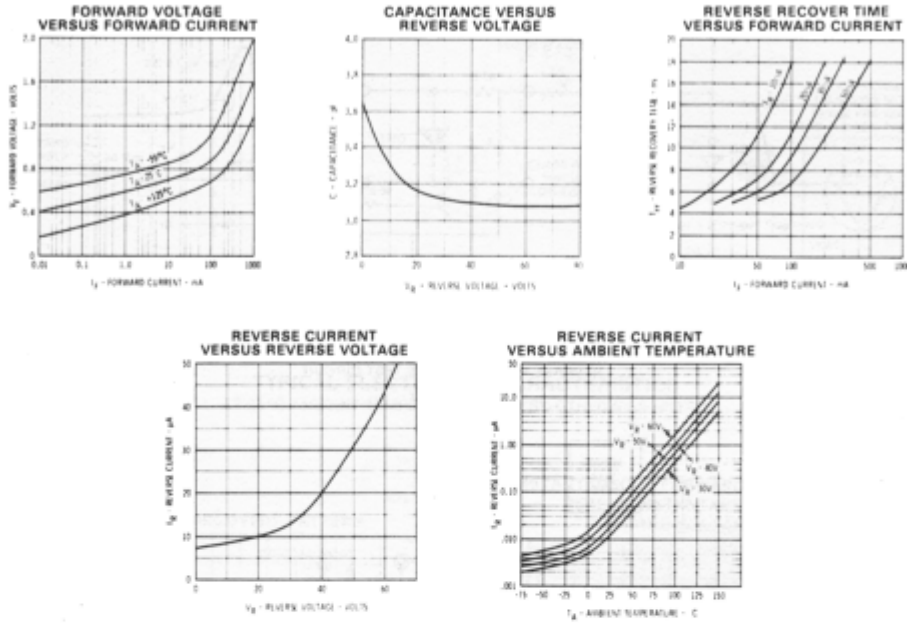

TEST CIRCUITS

To measure reverse current of an individual diode, the following test circuits are used:

COMMON CATHODE DIODES

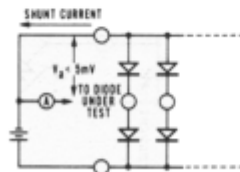

COMMON ANODE DIODES

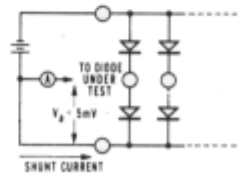

CURVE SET NUMBER D15
AIR-ISOLATED MONOLITHIC DIODE ARRAY

TEST CIRCUITS

Test requirement for V_{FM} and t_{rr} is as shown below; all leads should be as short as possible.

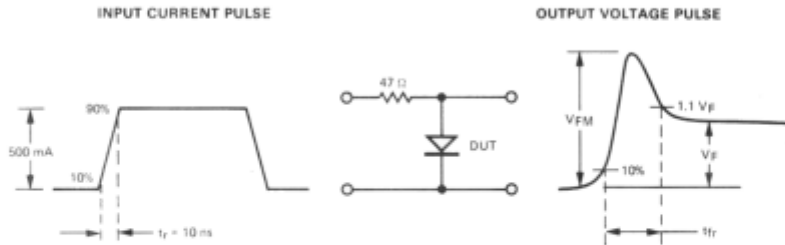

t_{rr} - REVERSE RECOVERY TIME TEST CIRCUIT
 $I_f = I_r, I_{rr} = 0.1 I_f$

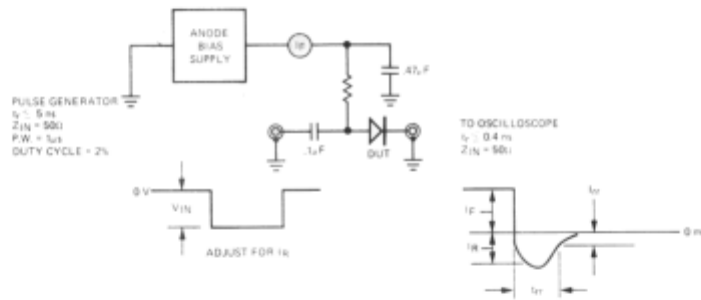

ΔV_F BRIDGE MATCHING CIRCUIT

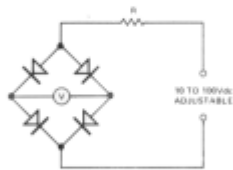

ΔI_R BRIDGE MATCHING CIRCUIT

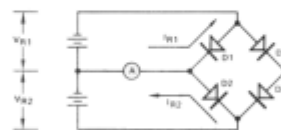

NOTES:

1. R Varies depending on the current range. For the most often used current ranges, R is as follows:

Current Range (amperes)	R (ohms)
10^{-5} to 10^{-4}	10^6
10^{-4} to 10^{-3}	10^5
10^{-3} to 10^{-2}	10^4
or 10^{-n} to 10^{-n+1}	10^{n+1}

2. V indicates mismatch of assembly.

NOTES:

- $V_{R2} = V_{R1} \pm 1\%$.
- $I_{R2} - I_{R1} = \Delta I_R$ (difference in I_R between diodes D1 & D2). To measure diodes D3 & D4, reverse cathode-anode terminal connections.
- A is a center reading pico ammeter. ΔI_R indicated directly on A.