

Silicon Diode

1N5187

200V / 3A

DATASHEET

OEM – Unitrode

Source: Unitrode Databook 1989-1990

RECTIFIERS

Military Approved, 3 Amp,
Fast Recovery

1N5186-1N5190
JAN & JANTX

FEATURES

- Continuous Rating: 3A
- Qualified to MIL-S-19500/424
- PIV : to 600V
- Recovery Time: 150ns
- Miniature Size
- Controlled Avalanche

DESCRIPTION

These miniature fast recovery rectifiers permit operation at full power at frequencies as high as 100kHz sine wave. They are qualified to military specification and available as JAN, JANTX

ABSOLUTE MAXIMUM RATINGS

Peak Inverse Voltage	Type
100V	JAN & JANTX 1N5186
200V	JAN & JANTX 1N5187
400V	JAN & JANTX 1N5188
600V	JAN & JANTX 1N5190

Maximum Average D.C. Output Current

@ $T_A = 25^\circ\text{C}$ 3.0A
 @ $T_A = 150^\circ\text{C}$ 0.7A

Non-Repetitive Sinusoidal

Surge Current (8.3ms) 80A

Operating Temperature Range -65°C to $+175^\circ\text{C}$

Storage Temperature Range -65°C to $+200^\circ\text{C}$

Thermal Resistance See Lead Temperature Derating Curve

MECHANICAL SPECIFICATIONS

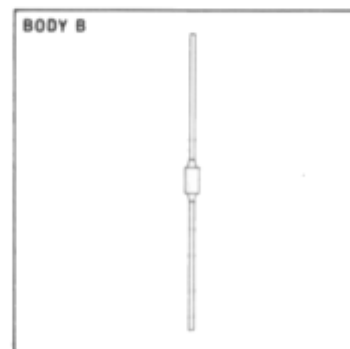
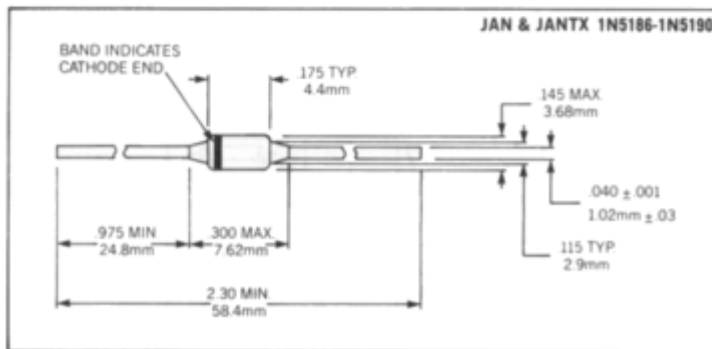

THESE DEVICES ALSO AVAILABLE IN SURFACE MOUNT PACKAGE. SEE SECTION 11.

JAN, JANTX 1N5186-1N5190

ELECTRICAL SPECIFICATIONS (at 25°C unless noted)

Type	Peak Inverse Voltage	Minimum Reverse Breakdown Voltage @ 100µA	Peak Forward Voltage		Maximum Reverse D.C. Current @ PIV	
			Min.	Max.	25°C	100°C
J, JTX 1N5186	100V	120V	0.9V @ 9A(pk) (8.3ms)	1.5V	2µA	100µA
J, JTX 1N5187	200V	240V				
J, JTX 1N5188	400V	480V				
J, JTX 1N5190	600V	660V				

Type	Reverse Recovery Time*	Capacitance @ $V_R = 0V$ $f = 1MHz$	Capacitance @ $V_R = 4V$ $f = 1MHz$
J, JTX 1N5186	150ns	300pf	200pf
J, JTX 1N5187	200ns	300pf	170pf
J, JTX 1N5188	250ns	230pf	120pf
J, JTX 1N5190	400ns	180pf	90pf

*Recovery time measured from $I_F = 0.5A$ to $I_R = 1.0A$, $t_{RR} = 0.25A$

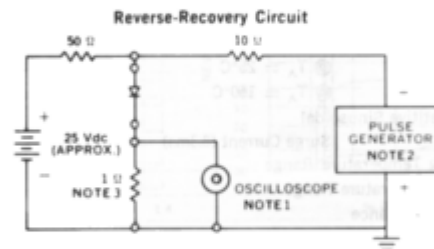
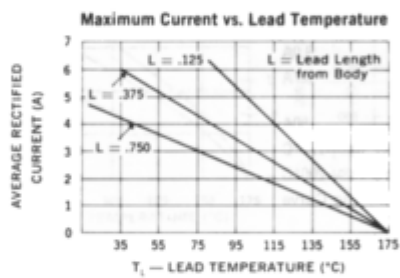

- NOTES:**
- Oscilloscope: Rise time < 3ns; input impedance = 50Ω.
 - Pulse Generator: Rise time < 8ns; source impedance 10Ω.
 - Current viewing resistor, non-inductive, coaxial recommended.

