

Silicon Dual Diode

BYV40E-200

200V/1.5A

DATASHEET

OEM – Philips

Source: Philips Databook 1999

Rectifier diodes ultrafast, rugged

BYV40E series

FEATURES

- Low forward volt drop
- Fast switching
- Soft recovery characteristic
- Reverse surge capability
- High thermal cycling performance
- low profile surface mounting package

SYMBOL

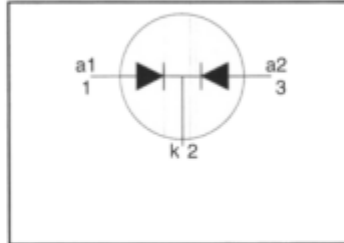

QUICK REFERENCE DATA

$$V_R = 150 \text{ V} / 200 \text{ V}$$

$$V_F \leq 0.7 \text{ V}$$

$$I_{O(AV)} = 1.5 \text{ A}$$

$$I_{RRM} = 0.1 \text{ A}$$

$$t_{tr} \leq 25 \text{ ns}$$

GENERAL DESCRIPTION

Dual, common cathode, ultra-fast, epitaxial rectifier diodes intended for use as output rectifiers in high frequency switched mode power supplies.

The BYV40E series is supplied in the SOT223 surface mounting package.

PINNING

PIN	DESCRIPTION
1	anode 1
2	cathode
3	anode 2
tab	cathode

SOT223

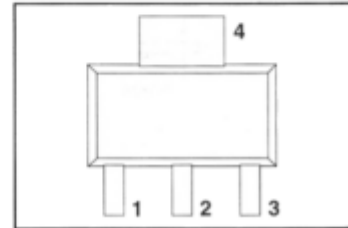

LIMITING VALUES

Limiting values in accordance with the Absolute Maximum System (IEC 134).

SYMBOL	PARAMETER	CONDITIONS	MIN.	MAX.		UNIT
				-150	-200	
V_{RRM}	Peak repetitive reverse voltage	BYV40E $T_{sp} \leq 120^\circ\text{C}$	-	150	200	V
V_{RWM}	Crest working reverse voltage		-	150	200	V
V_R	Continuous reverse voltage		-	150	200	V
$I_{O(AV)}$	Average rectified output current (both diodes conducting) ¹	square wave; $\delta = 0.5$; $T_{sp} \leq 132^\circ\text{C}$	-	1.5		A
I_{FRM}	Repetitive peak forward current per diode	$t = 25 \mu\text{s}$; $\delta = 0.5$; $T_{sp} \leq 132^\circ\text{C}$	-	1.5		A
I_{FSM}	Non-repetitive peak forward current per diode	$t_p = 10 \text{ ms}$	-	6		A
		$t_p = 8.3 \text{ ms}$	-	6.6		A
I_{RRM}	Repetitive peak reverse current per diode	sinusoidal; $T_j = 150^\circ\text{C}$ prior to surge; with reapplied $V_{RWM(max)}$ $t_p = 2 \mu\text{s}$; $\delta = 0.001$	-	0.1		A
I_{RSM}	Non-repetitive peak reverse current per diode	$t_p = 100 \mu\text{s}$	-	0.1		A
T_{stg}	Storage temperature		-65	150		$^\circ\text{C}$
T_j	Operating junction temperature		-	150		$^\circ\text{C}$

¹ Neglecting switching and reverse current losses

Rectifier diodes
ultrafast, rugged

BYV40E series

ESD LIMITING VALUE

SYMBOL	PARAMETER	CONDITIONS	MIN.	MAX.	UNIT
V_C	Electrostatic discharge capacitor voltage	Human body model; $C = 250 \text{ pF}$; $R = 1.5 \text{ k}\Omega$	-	8	kV

THERMAL RESISTANCES

SYMBOL	PARAMETER	CONDITIONS	MIN.	TYP.	MAX.	UNIT
$R_{th(j-sp)}$	Thermal resistance junction to solder point	one or both diodes conducting	-	-	15	K/W
$R_{th(j-a)}$	Thermal resistance junction to ambient	pcb mounted; minimum footprint	-	156	-	K/W
		pcb mounted; pad area as in fig:11	-	70	-	K/W

ELECTRICAL CHARACTERISTICS

characteristics are per diode at $T_j = 25 \text{ }^\circ\text{C}$ unless otherwise stated

SYMBOL	PARAMETER	CONDITIONS	MIN.	TYP.	MAX.	UNIT
V_F	Forward voltage	$I_F = 0.5 \text{ A}$; $T_j = 150 \text{ }^\circ\text{C}$	-	0.50	0.7	V
		$I_F = 1.5 \text{ A}$	-	0.82	1.0	V
I_R	Reverse current	$V_R = V_{RWM}$; $T_j = 100 \text{ }^\circ\text{C}$	-	100	300	μA
		$V_R = V_{RSM}$	-	5	10	μA
Q_s	Reverse recovery charge	$I_F = 2 \text{ A}$; $V_R \geq 30 \text{ V}$; $-di_F/dt = 20 \text{ A}/\mu\text{s}$	-	-	11	nC
t_{rr1}	Reverse recovery time	$I_F = 1 \text{ A}$; $V_R \geq 30 \text{ V}$; $-di_F/dt = 100 \text{ A}/\mu\text{s}$	-	-	25	ns
t_{rr2}	Reverse recovery time	$I_F = 0.5 \text{ A}$ to $I_R = 1 \text{ A}$; $I_{rec} = 0.25 \text{ A}$	-	10	20	ns
V_{fr}	Forward recovery voltage	$I_F = 2 \text{ A}$; $di_F/dt = 20 \text{ A}/\mu\text{s}$	-	3	-	V

Rectifier diodes
ultrafast, rugged

BYV40E series

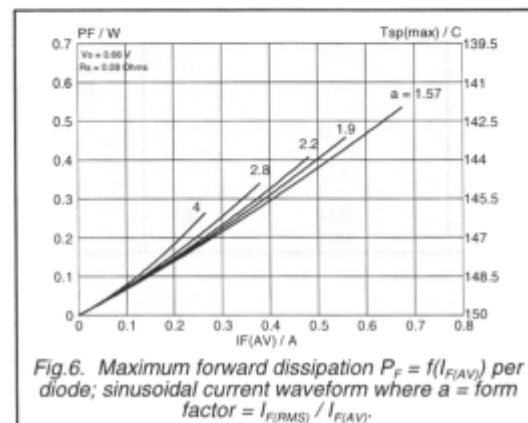
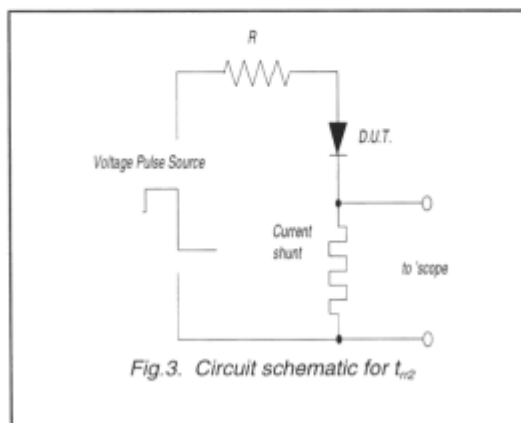
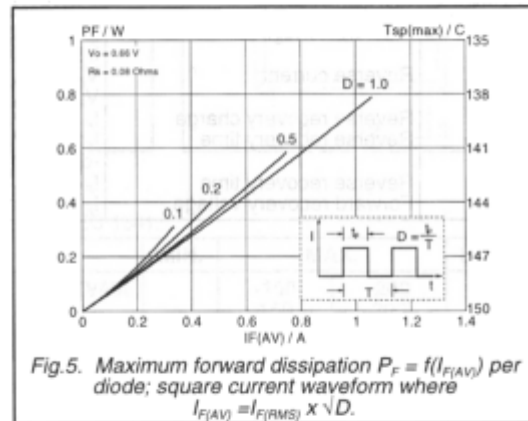
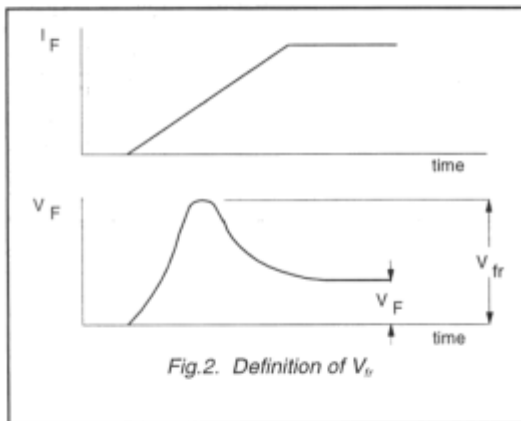
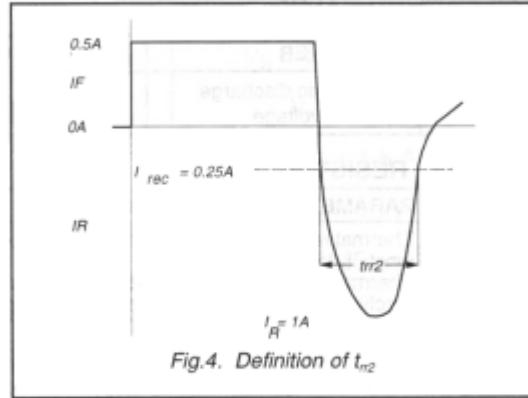
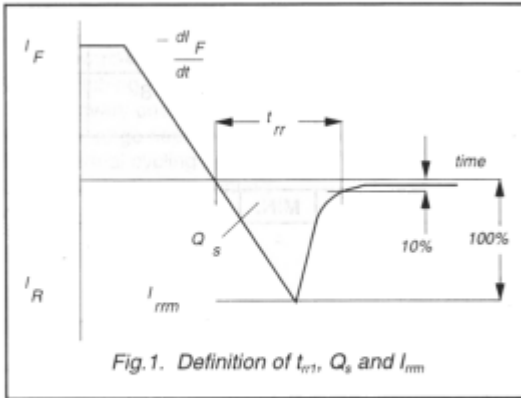

Rectifier diodes
ultrafast, rugged

BYV40E series

