

Solid State Relais

PVA3055

Photovoltaic Relais

DATASHEET

OEM – International Rectifier

Source: International Rectifier Databook 1995

Data Sheet No. PD-1.030B

INTERNATIONAL RECTIFIER

SERIES PVA30
Microelectronic
Power IC Relay

Single Pole, 40 mA
0-300V AC/DC

BOSFET® PhotoVoltaic Relay

GENERAL DESCRIPTION

The Photovoltaic AC Relay (PVA) is a single-pole, normally open solid state replacement for electro-mechanical relays used for general purpose switching of analog signals. It utilizes as an output switch a unique bidirectional (AC or DC) MOSFET power IC termed a BOSFET. The BOSFET is controlled by a photovoltaic generator of novel construction, which is energized by radiation from a dielectrically isolated light emitting diode (LED).

PVD FEATURES

The PVA30 Series combines very low solid state output capacitance, very high off-state resistance and very fast response. These Photovoltaic Relays are designed specifically to accurately switch low level signals in high performance instrumentation systems.

The PVA overcomes the limitations of both conventional and reed electromechanical relays by offering the solid state advantages of long life, high operating speed, low pick-up power, bounce free operation, low thermal voltages and miniaturization. These advantages allow product improvement and design innovations in many applications such as process control, multiplexing, telecommunications, automatic test equipment, and data acquisition.

The PVA30 Series can switch analog signals from thermocouple level to 300 volts peak AC or DC polarity. Signal frequencies into the RF range are easily controlled and switching rates up to 25 kHz are achievable.

The extremely small thermally generated offset voltages allow increased measurement accuracies. The critical output semiconductors are completely shielded from the infra-red radiation of the input LED. Therefore, photocurrents in the output BOSFET are nonexistent and there is not an output offset resulting from radiation from the input LED drive.

Unique silicon technology developed by International Rectifier forms the heart of the PVA. The monolithic BOSFET contains a bidirectional N channel power MOSFET output structure. In addition, this power IC chip has input circuitry for fast turn-off and gate protection functions. This section of the BOSFET chip utilizes both bipolar and MOS technology to form NPN transistors, P channel MOSFETs, resistors, diodes and capacitors.

The photovoltaic generator similarly utilizes a unique International Rectifier alloyed multijunction structure. The excellent current conversion efficiency of this technique results in the very fast response of the PVA microelectronic power IC relay.

This advanced semiconductor technology has created a radically new control device. Designers can now develop switching systems to new standards of electrical performance and mechanical compactness.

(Bosfet is a trademark of International Rectifier)

- BOSFET Power IC
- 10¹⁰ Operations
- 25 μ Sec Operating Time
- Low Output Capacitance
- 0.2 μ Volt Thermal Offset
- Offset independent of input drive
- 3 milliwatts Pick-Up Power
- 1000V/μsec dv/dt
- Bounce Free
- 8 Pin DIP Package
- -40°C to 85°C
- UL Recognized



Part Identification

Part No.	Operating Voltage AC/DC	Sensitivity	Off-State Resistance
PVA3054	0-300V	5 mA	10 ¹⁰ ohms
PVA3055			10 ¹¹ ohms

BOSFET PVA30 PhotoVoltaic Relay

ELECTRICAL SPECIFICATIONS (-40°C ≤ T_A ≤ 85°C unless otherwise specified)

INPUT CHARACTERISTICS	PART NUMBERS		UNITS
	PVA3054	PVA3055	
Min. Control Current: (See Fig. 1) For 40 mA Continuous Load Current. For 22 mA Continuous Load Current.	5.0	5.0	(DC) mA @ 40°C mA @ 60°C
Max. Control Current for Off-State Resistance at 25°C	10		µA (DC)
Control Current Range (Caution: Current limit input LED. (See Fig. 6))	2.0 to 25		mA (DC)
Max. Reverse Voltage	7.0		V (DC)

OUTPUT CHARACTERISTICS	PVA3054	PVA3055	
Operating Voltage Range	0±300		V (peak)
Max. Load Current 40°C (See Fig. 1)	40		mA (DC)
Response Time @ 25°C (See Fig. 7 and 8)			
Max. T (on) @ 12 mA Control, 20 mA Load, 100 VDC	25		µs
Max T. (off) @ 12 mA Control, 20 mA Load, 100 VDC	15		µs
Max. On-State Resistance at 25°C (pulsed) (See Fig. 4) (10 mA Load 5 mA Control)	160		Ohms
Min. Off-State Resistance at 25°C @ 240 VDC	10 ¹⁰	10 ¹¹	Ohms
Max. Off-State Leakage at 25°C @ 5.0 VDC (See fig. 5)	-	0.05	nA
Max. Thermal Offset Voltage @ 5.0 mA Control V _O (OS)	0.2		µ volts
Min. Off-State dv/dt	1000		V/µs
Max. Output Capacitance (See Fig. 9)	3.0		pF @ 40 VDC

GENERAL CHARACTERISTICS	ALL MODELS		
Dielectric Strength-Input/Output	2500		V (RMS)
Insulation Resistance @ 90 VDC-Input/Output	10 ¹² @ 25°C - 50% RH		Ohms
Max. Capacitance-Input/Output	1.0		pf
Lead Temperature (1.6 mm below seating plane) for 10 seconds	260		°C
Ambient Temperature Range:	Operating	-40 to 85	°C
	Storage	-40 to 100	°C

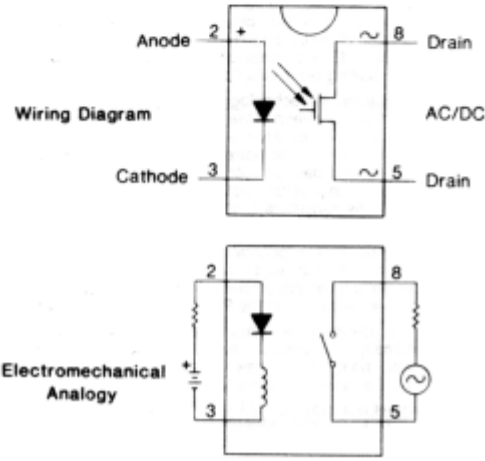
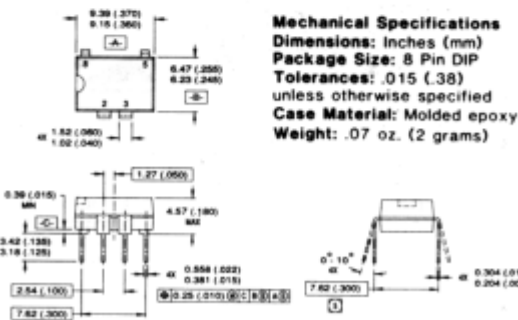

BOSFET PVA30

PERFORMANCE CHARACTERISTICS CURVES

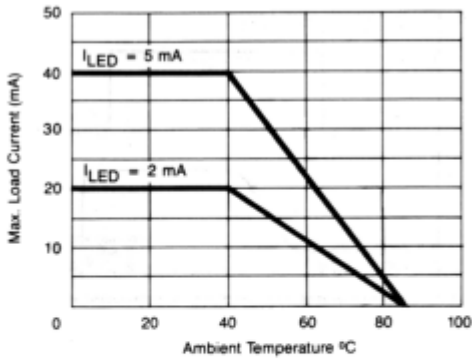

Figure 1. Current Derating Curves

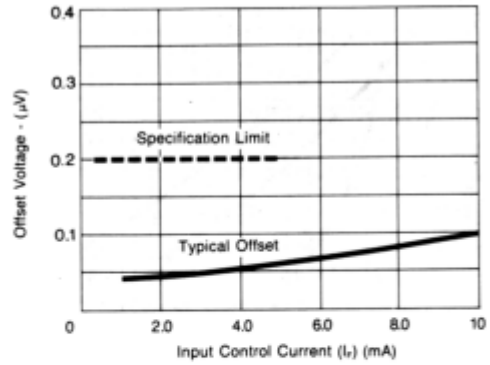

Figure 2. Offset Voltage

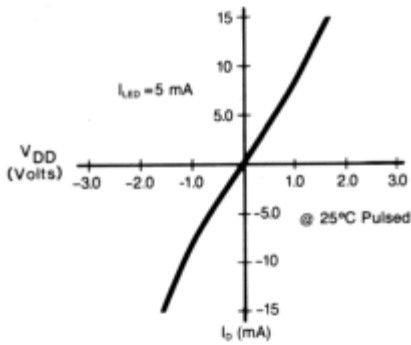

Figure 3. Typical On Characteristic

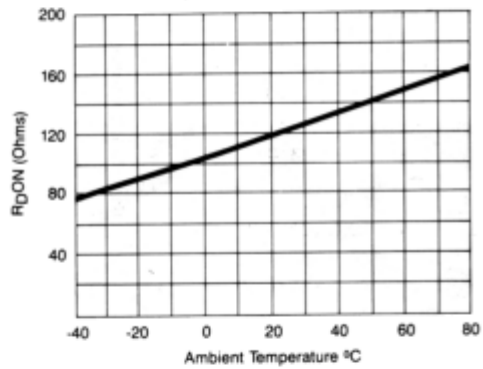

Figure 4. Typical On Resistance

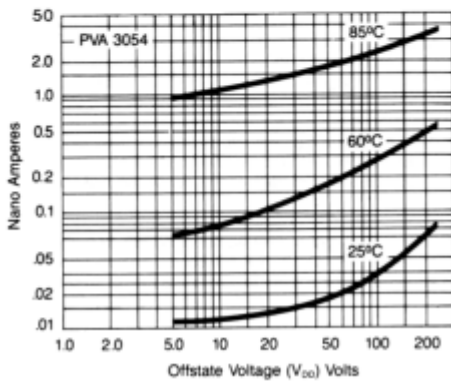

Figure 5. Typical Variation of Offstate Leakage Current

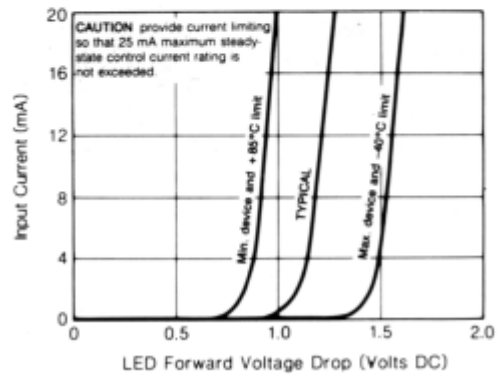

Figure 6. Input Characteristics (Current Controlled)

BOSFET PVA30 PhotoVtaic Relay PERFORMANCE CHARACTERISTICS CURVES

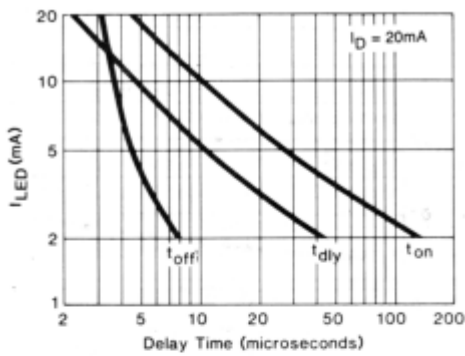

Figure 7. Typical Delay Times

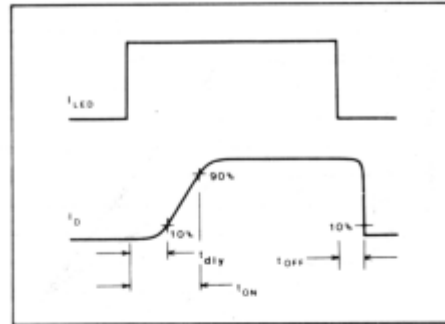

Figure 8. Delay Time Definitions

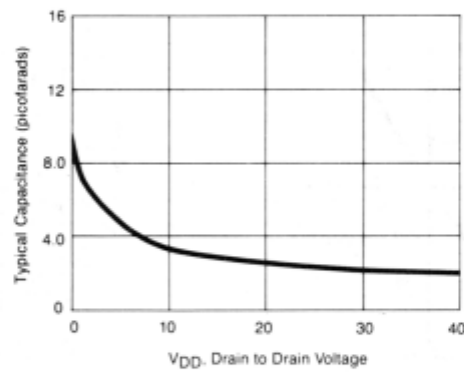

Figure 9. Typical Output Capacitance