

Bridge Rectifier

B125C800DM

125V / 0,8A

DATASHEET

from

www.web-bcs.com

OEM – General Semiconductor

Source: General Semiconductor Databook 1998

B40C800DM THRU B380C800DM

MINIATURE GLASS PASSIVATED SINGLE-PHASE BRIDGE RECTIFIER

Reverse Voltage - 65 to 600 Volts Forward Current - 0.9 Ampere

Case Style DFM

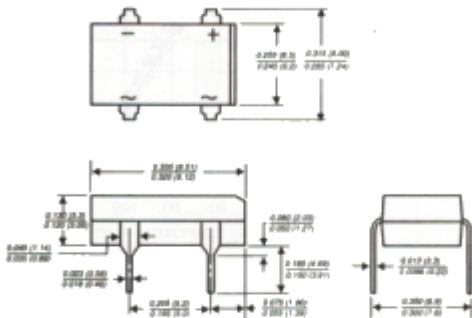

Dimensions in inches and (millimeters)

FEATURES

- ◆ Plastic package has Underwriters Laboratory Flammability Classification 94V-0
- ◆ Glass passivated chip junctions
- ◆ Surge overload rating of 45 Amperes peak
- ◆ Ideal for printed circuit boards
- ◆ High temperature soldering guaranteed: 260°C/10 seconds at 5 lbs. (2.3kg) tension



MECHANICAL DATA

Case: Molded plastic body over passivated junctions
Terminals: Plated leads solderable per MIL-STD-750, Method 2026
Polarity: Polarity symbols marked on body
Mounting Position: Any
Weight: 0.04 ounce, 1.0 gram

MAXIMUM RATINGS AND ELECTRICAL CHARACTERISTICS

Ratings at 25°C ambient temperature unless otherwise specified.

	SYMBOLS	B40 C800DM	B60 C800DM	B125 C800DM	B250 C800DM	B380 C800DM	UNITS
Maximum repetitive peak reverse voltage	V _{RRM}	65	125	200	400	600	Volts
Maximum RMS input voltage R + C-load	V _{RMS}	40	80	125	250	380	Volts
Maximum average forward output current for free air operation at T _A =45°C R + L-load C-load	I(AV)	0.9 0.8					Amp
Maximum DC blocking voltage	V _{DC}	65	125	200	400	600	Volts
Maximum peak working voltage	V _{RWM}	90	180	300	600	900	Volts
Maximum non-repetitive peak voltage	V _{RSM}	100	200	350	650	1000	Volts
Maximum repetitive peak forward surge current	I _{FRM}	10.0					Amps
Peak forward surge current single sine wave on rated load at T _J =125°C	I _{FSM}	45.0					Amps
Rating for fusing at T _J =125°C (t<100ms)	I _T	10.0					A'sec
Minimum series resistor C-load at V _{RMS} = ±10%	R _T	1.0	2.0	4.0	8.0	12.0	Ohms
Maximum load capacitance +50% -10%	C _L	5000	2500	1000	500	200	µF
Maximum instantaneous forward voltage drop per leg at 0.9A	V _F	1.0					Volts
Maximum reverse current at rated repetitive peak voltage per leg	I _R	10.0					µA
Typical thermal resistance per leg (NOTE 1)	R _{θJA} R _{θJL}	40.0 15.0					°C/W
Operating junction temperature range	T _J	-40 to +125					°C
Storage temperature range	T _{STG}	-40 to +150					°C

NOTES: (1) Thermal resistance from junction to ambient and from junction to lead P.C.B. mounted on 0.5 x 0.5" (13 x 13mm) copper pads

RATINGS AND CHARACTERISTICS CURVES B40C800DM THRU B380C800DM

